

REVISION	DESCRIPTION	CHECK	APP	DATE	REV. NOTICE. NO
△1					
△2					
△3					

QFN56-0.5转接板连线图

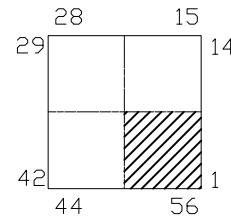

IC 脚位图

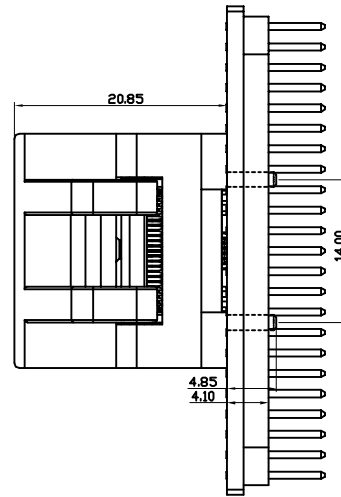
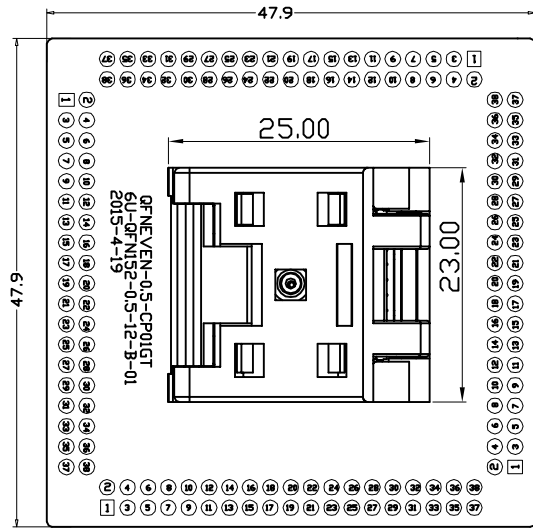
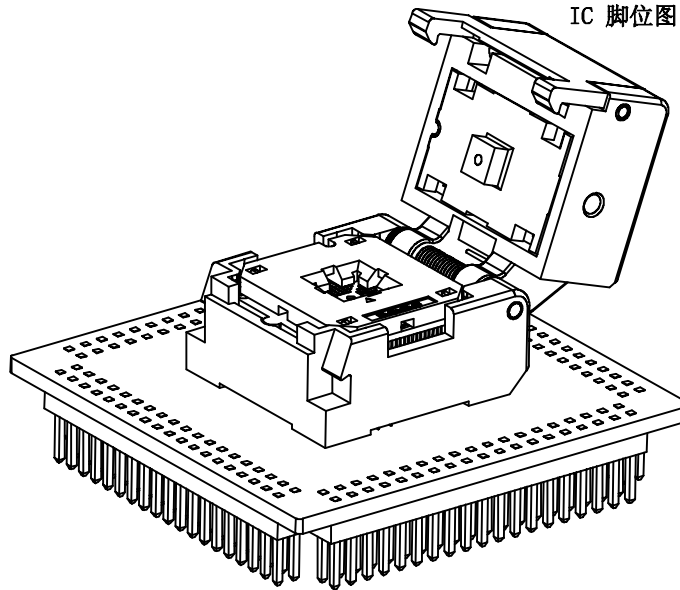
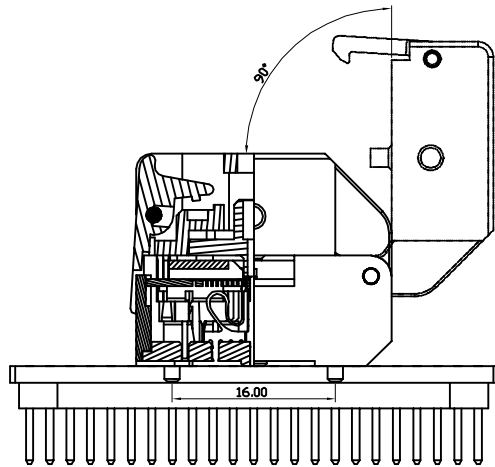
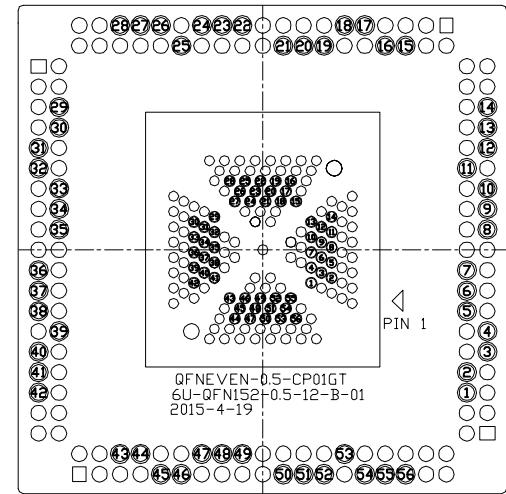

Applicable IC

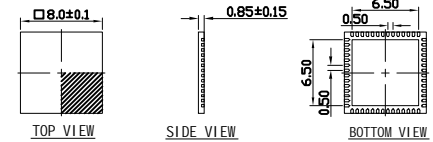

PROJECTION		GENERAL TOLERANCES	±0.10	TITLE	QFN56-0.5 SOCKET
DIMENSION:	mm	R E V	A	CLASS	QFN056-0.5-CP01G
APP:		SCALE:	1:1	DRW. NO	QFN056-0.5-CP01G-A-01
CHECK:		DATE:			
DECK:		DATE:	20120822		